

Structural Design Optimization of the SAR Plate Assembly Through Genetic Algorithm

Ezgi KIRMAN¹, Sergio RICCI², Giuseppe TORRACO³, Claudio CAVALLERO⁴ and Luca FATTORE⁴

¹Politecnico di Milano - kirman.ezgi@gmail.com

²Politecnico di Milano - sergio.ricci@polimi.it

³AgustaWestland - giuseppe.torraco@agustawestland.com

⁴Exemplar srl - {claudio.cavallero, luca.fattore}@exemplar.com

Abstract: Advances in computational technologies allow further improvements regarding the efficiency of the preliminary design phase. Specialized softwares enable the integration and the optimization of a process flow with the scope of reducing time and costs while significantly improving product performance, quality, and reliability. This work consists of an Isight application with the aim of automation and optimization of a structural design process of the SAR Plate Assembly. The multiobjective optimization problem that regards this specific helicopter component is handled through the use of 4 different genetic algorithms. Once the procedure of finite element analysis is automated, new design solutions are obtained by finding a compromise between the objective functions related to mass and vibration frequencies. Topologically different design solutions are systematically tested and perfected by sizing and internal parameter optimization in manner to obtain a light and dynamically tailored structure.

Keywords: SAR Plate Assembly, multi objective optimization, genetic algorithms, Isight, structural optimization

1. Introduction

The helicopter component that constitutes the main focus of the optimization process is basically a rectangular plate which is typically used for "Search and Rescue (SAR)" operations. The main function of the SAR Plate Assembly is to carry the necessary auxiliary equipment such as oxygen bottles or any other item required for the specific task [Figure 1]. Design and required analysis for the certification of this component are already completed and it is currently in the construction phase. Consequently, all the activities covered in this paper do not have an intention to redesign an object to be constructed but proposes an alternative design at academic level.

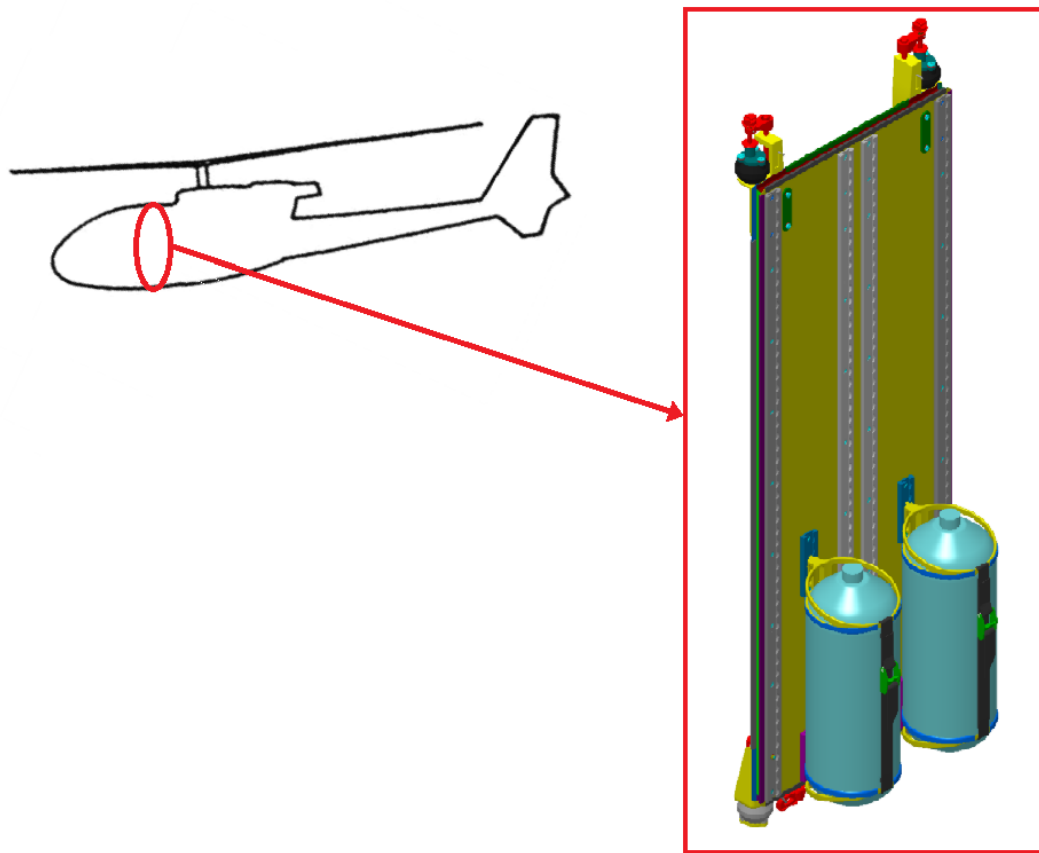

Figure 1. - SAR Plate Assembly.

2. Problem Formulation

Main purpose of this optimization problem is to find an alternative structural design solution that is capable of respecting the present constraints. Component is attached to the helicopter through 6 shock absorbers which fundamentally work as a filter. The new design solution should exclude the use of these additional suspension elements which do not really make part of the structure. At this point, it becomes indispensable the dynamic response analysis of the system in order to avoid undesired vibrations due to resonance peaks. For this specific case, the frequencies that should be avoided correspond to 4 and 8 times the main rotor frequency, including a tolerance band of $\pm 10\%$.

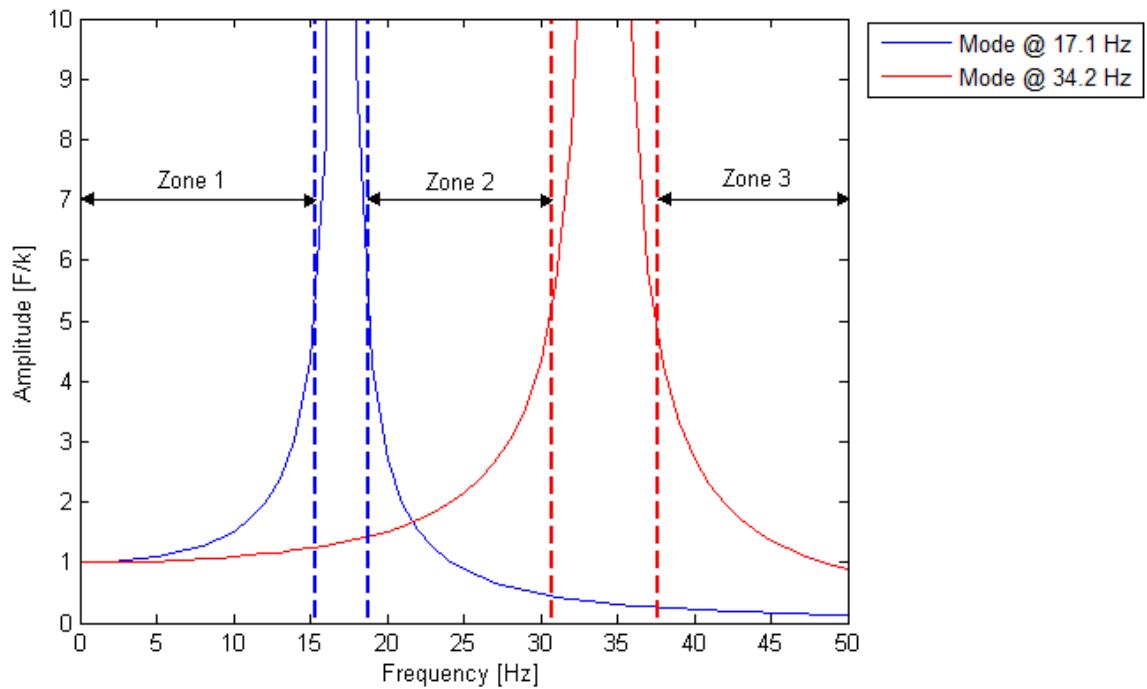

Figure 2. - Limits of the acceptable frequency zones.

As illustrated in Figure 2, these two main forcing frequencies create precise zones where the input does not cause amplification problems due to resonance. By considering robustness problems at static analysis level, the operational frequency band of the new solution is placed in the third zone by setting a lower frequency limit equal to 38Hz.

The whole work of optimization can be divided into 4 main groups which represent topologically different structures. For each of these configurations, an adequate finite element model of the plate is constructed and integrated into the Work flow regarding the optimization process. After these two main steps that automates the process, simulations are run for a predefined number of iterations and then the results are examined and interpreted. To sum up, the activity sequence for each design solution can be listed in the following manner:

- Construction of a simplified FEM of the component
- Model verification
- Preparation of the work flow as a task in Isight
- Optimization problem statement

- Algorithm selection and parameter tuning
- Execution of the automated optimization process
- Post-processing

After highlighting the main approach adopted during the whole process, it is possible to specify the main elements of the optimization problem: objectives, constraints and design variables. For all configurations, the two objectives are set as minimization of the plate mass¹ and the maximization of the first global frequency. The constraints are determined by the interface load limits, material strength limits and the lower frequency threshold. Whereas, the design variables change from a configuration to another and they are listed for each case. Note that during the optimization process, topology, sizing, shape and internal parameter optimization techniques are used. In this early stage, it would be useful to emphasize that topologically different design solutions are not obtained as result of a conventional optimization process but they are gradually determined by the "decision maker".

The last aspect to be determined is the selection of the optimization algorithms that are going to be employed during the whole process. Based on the nature of the problem, the class of genetic algorithms is the most suitable for this kind of application. In addition to their efficiency, some of other reasons for such a choice can be listed as follows: presence of a multi-objective optimization problem and discrete design variables and the duration of a single Work flow iteration. Consequently, *Neighborhood Cultivation Genetic Algorithm* (NCGA), *Archive-Based Micro Genetic Algorithm* (AMGA), *Multi-Island Genetic Algorithm* (MIGA) and *Non-dominated Sorting Genetic Algorithm* (NSGA-II) are used. All these optimization techniques are available in *Isight*.

3. Configuration 1: Metallic sandwich model

The starting point in order to select the structure regarding the first configuration has been the original design of the SAR Plate Assembly. Consequently, a metallic sandwich model is adopted in order to initiate the optimization process. The decisions regarding the finite element modeling are taken in a manner to obtain a simple model that is at the meanwhile an accurate approximation of the reality. Note that the complexity of the model significantly increases the time required for the solver. As a result of this, the FEM that is going to be used during the process would be a compromise between the total optimization time and the complexity regarding the modeling. To illustrate, the honeycomb part is modeled through planar shell elements instead of three dimensional solid ones.

¹ The mass corresponding to the original SAR Plate design with the removal of the shock absorbers is equal to 9.07 kg and this value is used as a mass threshold during the entire process

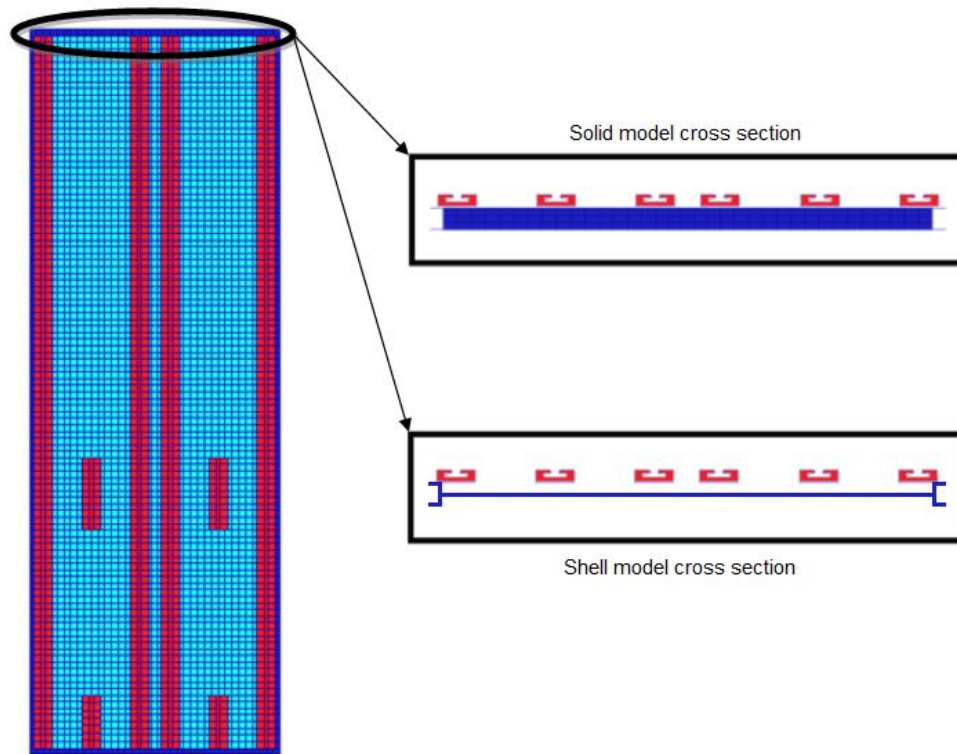

Figure 3. - FEM with solid and shell elements.

For this first configuration, the design variables can be listed as in the following manner. Honeycomb and skins thicknesses can be considered as fundamental elements that may change the response of the plate. It is possible to observe that these variables have a discrete range that are tabulated in the catalogues. Whereas the reinforcement elements do not have such a constraint and possess a continuous range regarding its dimensions.

Once the Work flow that comprehends both static and dynamical analysis is constructed and the optimization parameters are set, all the algorithms are tested in order to find the best one for this application. In order to be able to compare different algorithms, approximately equivalent conditions are created. This means that the total iteration number is kept equal for each algorithm. In addition to this, the population size and the number of generation are selected in a coherent way for each of them. Even though this is a very basic and not worthing manner of comparing different algorithms, it gives an idea about the quality of the results for this application. The **Figure 4** demonstrates that AMGA and NSGA II permit to obtain a clearer Pareto front with respect to the other ones. The best solution which respects the lower frequency limit is equal to 16.90 kg and it is obtained through AMGA. However, this mass value is not acceptable because it is highly superior to the mass of the original design which that is equivalent to 9.07 kg. Even though a

better design alternative is not found, the post processing enables to reach important information regarding the nature of the problem.

Table 1.- Design variables for metallic sandwich model.

Design Parameters	Allowed Values - Ranges
Honeycomb thickness	[6.35 9.53 12.7 19.05 25.4 38.10] mm
Facing skin thickness	[0.2 0.22 0.25 0.3 0.35 0.41 0.51 0.64 0.81 1.02 1.27 1.6 2.03 2.54 3.18 4.06 4.83] mm
Honeycomb density	30-150 kg/m ³
Web thickness of the "C" reinforcement	0.2-2 mm
Flange thickness of the "C" reinforcement	0.2-2 mm

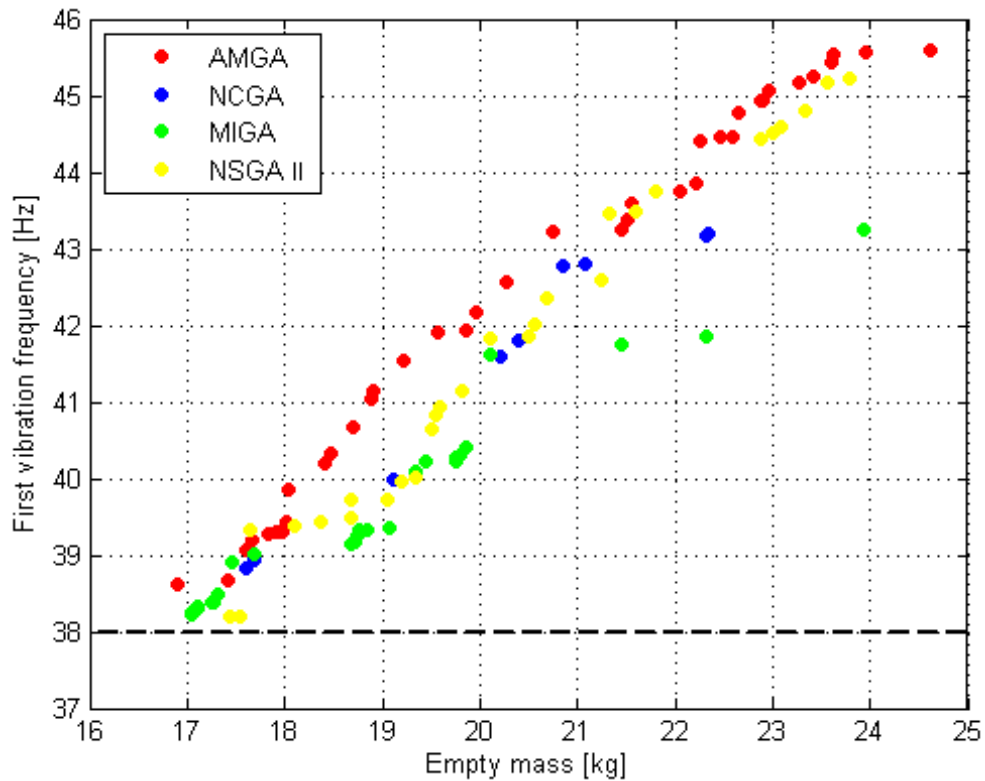

Figure 4. - Comparison of the Pareto front of different algorithms.

4. Configuration 2: Composite sandwich model

Results obtained for the metallic sandwich model showed that the considered design variables are not able to change the modal behavior of the plate in a drastic manner. Idea of using a sandwich structure is kept whereas the material choice is changed by switching from metal to composite. The main reason of taking such a decision relies on the fact that composite materials permit to obtain "tailored" material behavior by combining different factors. These factors principally depend on the material properties such as lamina or ply type, thickness and orientation angle. Consequently, the use of composite materials enables the user to have more design variables to vary so more design flexibility.

Before reaching the definitive and final model, various subcases are created and analyzed in order to orient the problem towards a smart direction that would reduce design variable number. To illustrate, in the case of a nomex honeycomb core, the facing skins and the "C" reinforcement elements around the plate should be made of composite material. This material can be either fabric or unidirectional. Analysis showed that for the same mass value, higher frequency values can be reached by the use of unidirectional material so this lamina type is more convenient than fabric. Moreover, based on the results obtained for the previous case, local reinforcement zones are introduced in order to have a more efficient material distribution. The results demonstrated that the thicker facing skins near the central zone gives better solutions. However, a precise indication about the width of these zones with respect to the plate height is not be obtained. Consequently, this element is considered among the design variables of the problem in addition to the quantity of these reinforcement layers. The latter is introduced by a reduction rate that respects some basic rules regarding the milling operation of a honeycomb core.

Table 2. - Design variables for composite sandwich model.

Design Parameters	Allowed Values - Ranges
Honeycomb thickness	[3.18 4.0 4.78 6.35 9.53 10.0 12.715.0 15.88 19.05 25.4 31.75 38.10 50.8] mm
Ply angles (skin layers)	[0 45 -45 90]
Ply number (skin layers)	[1:1:20]
Ply angles (reinforcement layers)	[0 45 -45 90]
Ply number ("C" reinforcement layers)	[2:2:14]
Ply angles ("C" reinforcement layers)	[0 45 -45 90]
Reduction rate	[0 0.25 0.5 0.75 1]
Flange width	8-16 mm
Limit of local reinforcement	[10% 33%]

Note that in order to reduce the design variable number, the lamina corresponding to facing skins and the "C" reinforcement elements are considered to be symmetric. As a result of this, a Script component is inserted in the Work flow that fills in the relevant information regarding the material type, orientation angle and the thickness. In other words, the indispensable input data to represent a planar composite element for each lamina. In addition to these, the global properties of the "C"

reinforcement elements are obtained by the implementation of the classic lamination theory through another Script component. In this way, the homogeneous material data required for a beam element is obtained.

Based on the results that are obtained for the metallic sandwich, the NCGA is not considered among the used optimization algorithms. One of the main differences between these two cases is that the composite sandwich model has much more design variables compared to the metallic one. This fact requires to increment the total iteration number in order to obtain a well defined Pareto front. The Figure 5 enables to make a comparison between the Pareto fronts obtained the remaining 3 algorithms.

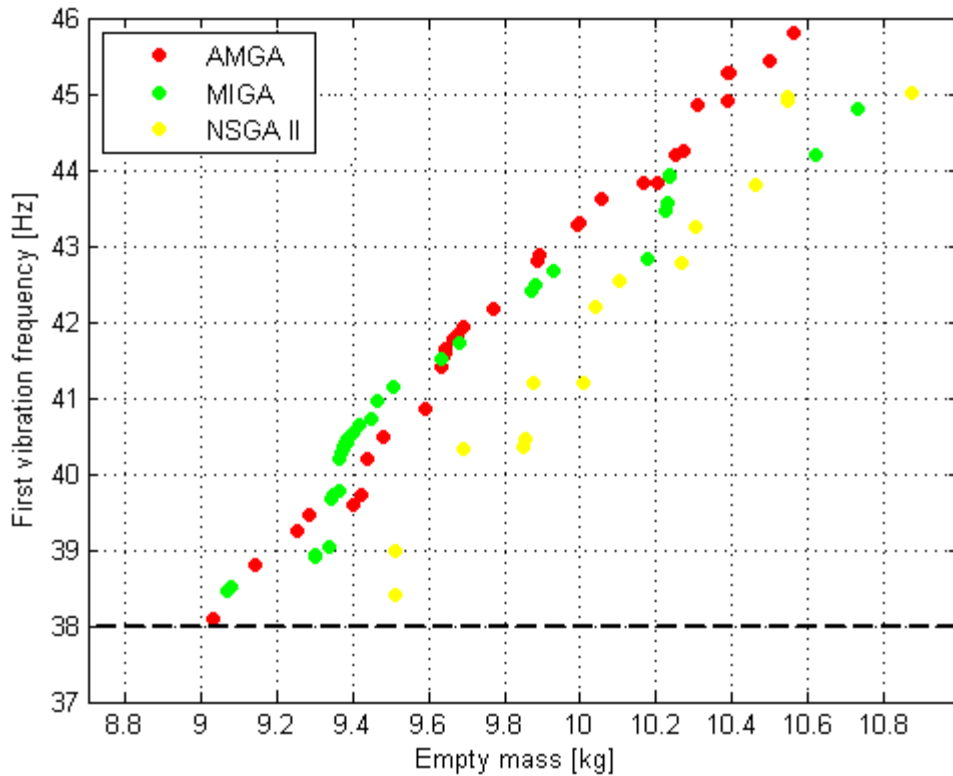

Figure 5. - Comparison of the Pareto front of different algorithms.

The results presented in Figure 5 confirm that the algorithm which led to the best solution is once again AMGA. Moreover, the profile of the Pareto front for this algorithm is much more regular with respect to the other ones. As a result of this, AMGA would be the unique algorithm that will be employed during the optimization processes regarding the next configurations. The

best feasible solution has a mass value that is equal to 9.03 kg. This obtained value is slightly inferior compared to the mass target that is previously fixed. This means that with this configuration and the parameters of the best feasible solution, SAR Plate can be redesigned in a manner that the shock absorbers can be removed

5. Configuration 3: Reinforced laminate model

The composite sandwich model proposed an alternative solution to the original SAR Plate design by removing the shock absorbers for the same mass value. However, another possible configuration is taken into consideration with the scope of reaching lower mass values. The use of a honeycomb core is one of the most widespread solutions used in the aerospace industry in order to gain inertia by introducing lowest weight possible. In the case of the SAR Plate Assembly, the dimensions of the honeycomb core correspond to the total plate area. This means that there might exist zones that are filled with core material even though it is not necessary. So these critical zones can be identified and reinforced in a manner to obtain the desired modal behavior. In order to achieve this objective, a configuration that has a unique facing skin which is reinforced by the stiffeners on its rear side is going to be considered [Figure 7].

For this case, the role of the "decision maker" is to decide the most appropriate cross section type in order to accelerate and simply the implementation of the problem. Note that among all the cross section shapes, the most suitable ones for this current case are "C" and "I". Their efficiency depends on the fact that they can further increase the inertia of the plate by positioning flanges that are more distant from the CoG of the entire system. Between these two possibilities the "C" form is more convenient for two main reasons: the first one is the ease of manufacturing. Instead the second one is related to the formulation of the optimization problem. As there already exist the "C" reinforcements that are present at the extremities of the plate, the same form and dimensions are preserved so that the number of design variables would not increase further.

In the previous cases, the limit along the y direction was equivalent to the maximum allowable honeycomb thickness available in the market. Instead for this case, there is not a limit regarding manufacturing issues. However, as the place of the plate in the helicopter is well defined, the dedicated volume determines the upper limit corresponding to the plate thickness. Consequently, the web height is set equal to this maximum allowable value in order to prevent an interference with the cabin wall.

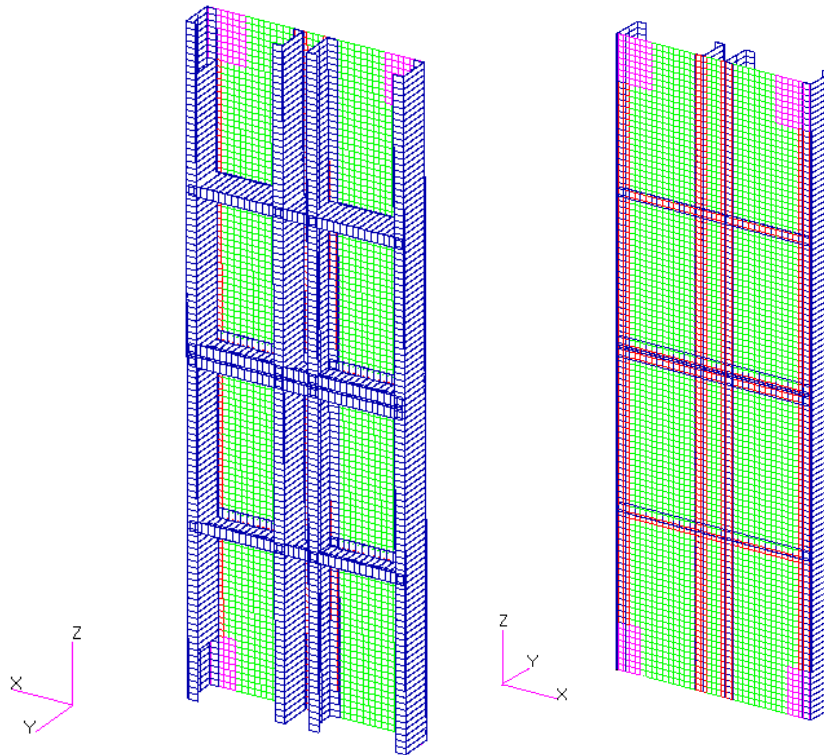

Figure 6. - FEM of the reinforced laminate: frontal (left) and rear (right) views.

Table 3. - Design variables for reinforced laminate model.

Design Parameters	Allowed Values - Ranges
Stiffener flange width	5-70 mm
Ply angles (skin layers)	[0 45 -45 90]
Ply number (skin layers)	[2:2:20]
Ply angles (reinforcement layers)	[0 45 -45 90]
Ply number (reinforcement layers)	[2:2:20]
Ply angles ("C" stiffener layers)	[0 45 -45 90]
Ply number ("C" stiffener layers)	[2:2:10]

Once this important parameter is fixed, the most significant design variable becomes the stiffener flange width [Figure 7]. The best feasible solution that is found by AMGA has a mass equal to 9.38 kg and a stiffener web height approximately equal to its maximum limit. This tendency to increase the flange width is logical because a system with more material further than

its CoG would have a higher inertia and consequently a higher natural frequency. Such a behavior would be the starting point of the next configuration.

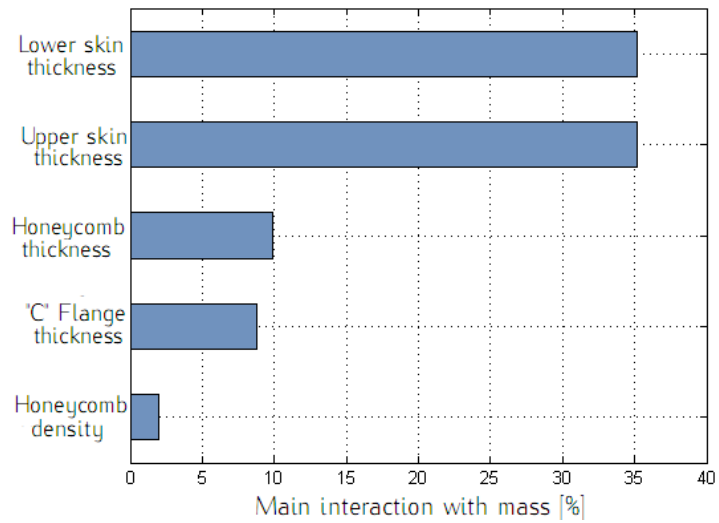
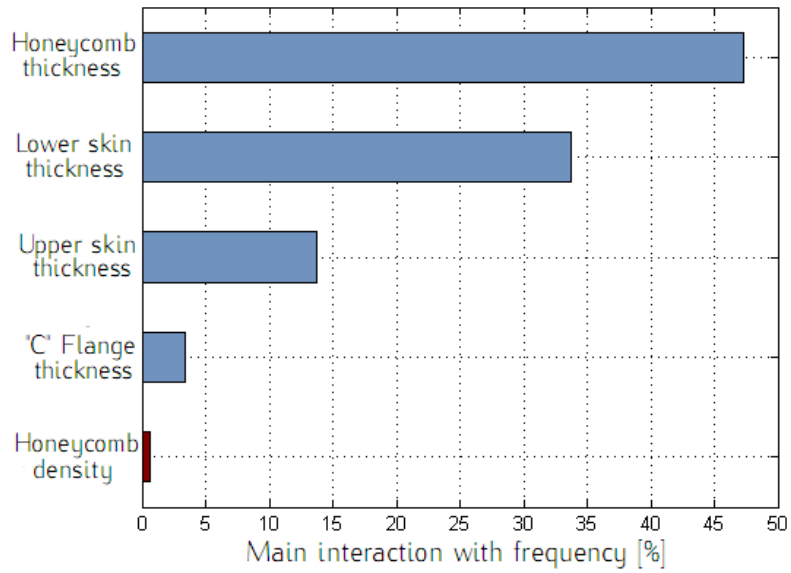

Figure 7. - Interactions between variables and objectives.

6. Configuration 4: Reinforced closed box model

The results obtained for the 3rd configuration gave important indications about the modal behavior of the plate and they led to further improve the model. Under the light of these indications, the 4th and final configuration is constructed. The main modification that is introduced to this model consists of a supplementary skin plate which is attached to the ends of the stiffeners. As in the honeycomb case, such a structural solution would be efficient in order to increase the k natural frequency due to the introduction of elements which have low ratio

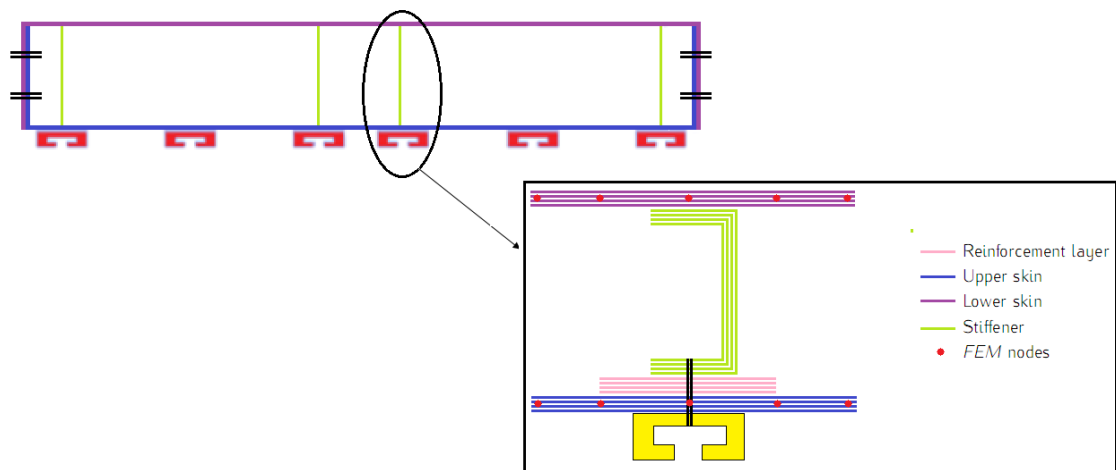

Figure 8. - Cross section of the final configuration.

Such a structural design has an operative problem that is quite widespread for aeronautical structures where high concentrated masses are attached to thin structures like in the case of an engine attached to a wing through the pylon. This problem comprehends the local modes that appear during modal analysis. However, the contribution of these local or panel modes to the overall dynamics is almost negligible. Consequently, the lower frequency boundary is always applied to global modes. After this specific remark, the design variables can be examined.

The workflow used for this configuration is illustrated in Figure 9. This represented sequence logic starts with the determination of the lamination characteristics of each laminate i.e. stiffener web, reinforcement layers, upper and lower facing skins. For the current model, upper skin and lower skin are considered to be independent from each other but individually symmetric. In this way, optimizer would have the freedom of disposing and orienting the plies where it is necessary. The second block calculates the material properties of the equivalent section regarding the stiffener flanges. In addition to this, their area, inertia and torsional constant are also obtained. The Data Exchanger block is employed in order to modify the node coordinates.

Table 4. - Design variables for reinforced closed box model.

Design Parameters	Allowed Values - Ranges
Stiffener web height	[20:5:70] mm
Stiffener flange width	10-50 mm
Ply angles (lower skin layers)	[0 45 -45 90]
Ply number (lower skin layers)	[2:2:10]
Ply angles (upper skin layers)	[0 45 -45 90]
Ply number (upper skin layers)	[2:2:10]
Ply angles (reinforcement layers)	[0 45 -45 90]
Ply number (reinforcement layers)	[2:2:10]
Ply angles ("C" stiffener layers)	[0 45 -45 90]
Ply number ("C" stiffener layers)	[2:2:20]

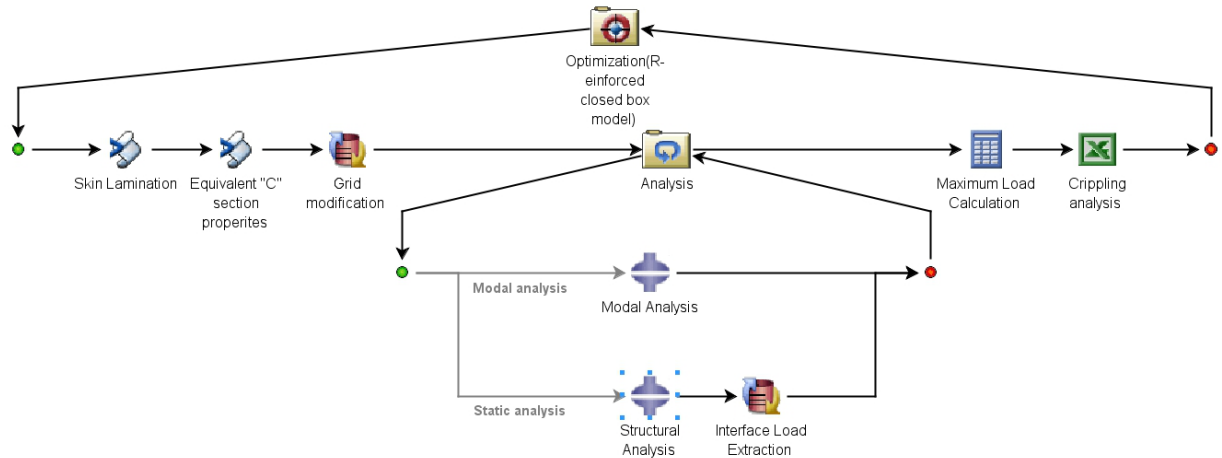

Figure 9. - Optimization of the reinforced close box model.

Such operation is necessary in order to be able to modify the stiffener height. Firstly, in the FEM, the nodes along y axis are renumbered in a systematic manner. Then the total height value is passed as an input to this component which gradually changes the y coordinate of the node blocks that correspond to different height levels present in the FEM input file. Afterwards, dynamic and static analysis are performed in order to retrieve the first global natural frequency and the maximum compression load on the stiffeners. This value is then passed to the Excel block where the formulas required for crippling analysis are implemented. At each iteration, the ultimate allowable crippling strength of the defined stiffener is calculated. Afterwards, the corresponding margin of safety is found by considering the maximum compression load on the critical elements. After this step, the cycle restarts with new design variable values.

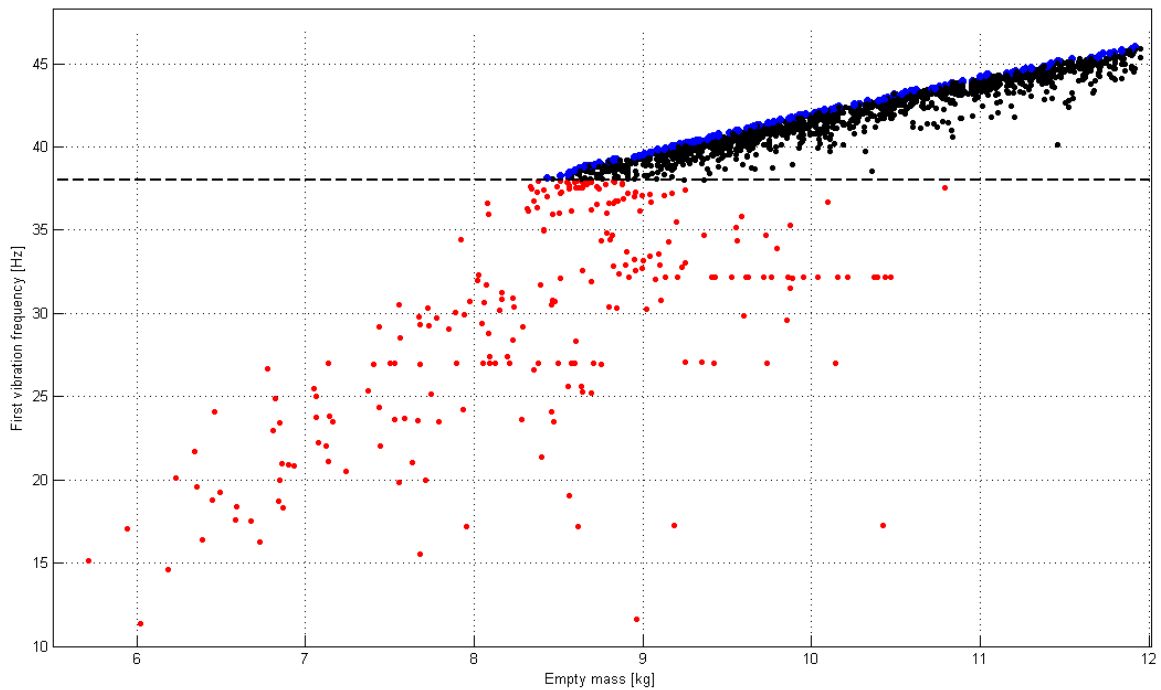

Figure 10. - Optimization of the reinforced close box model.

For this last configuration, several simulations with different techniques are run and in order to ensure the stability of the best feasible solution. To illustrate, firstly a simulation that has an exaggerated number of iteration is considered. Then the Pareto front obtained at the end of this simulation is given as an input to the next one. In fact, the results shown in fig. 10 demonstrate that the optimizer was more focused on improving the solution rather than exploring the design space. At the end, the best feasible solution is given as an input to a simulation that implements Simulated Annealing Method which may be more efficient to make a local search with respect to a genetic algorithm. Finally, it can be deduced that the best feasible solution obtained by AMGA is equal to 8.43 kg and this alternative solution that does not possess any suspension elements do not create dynamical problems and weights even less than the original design.

7. Results

During the entire optimization work, a work sequence is followed in order to minimize the mass of the SAR Plate Assembly by respecting the given frequency constraints. The validity of each solution is both statically and dynamically verified by considering the worst combination of different load conditions and loading configurations. The overall results that are obtained for each of 4 configuration are listed in tab. 1. It can be seen that the optimization process has been a gradual sequence and the last configuration has been the main focus. As the results in tab. 1 show,

Table 5 - Summary of the overall optimization process

Configuration No	Algorithm	Number of iteration	Total time [h]	Mass [kg]	Frequency [Hz]	Mass difference [%]
1	AMGA	1000	25.2	16.9	38.6	86.3
2	AMGA	1500	18.3	9.03	38.1	-0.4
3	AMGA	1500	4.5	9.38	38.1	3.4
4	AMGA	2500	45.5	8.43	38.2	-7.1

the total mass of the component is approximately reduced by 7%. Note that among all the genetic algorithms present in the software, AMGA has been the most suitable one for this application in accordance with Ph.D. thesis work of Recchia².

Apart from the numerical results, the important point is the ability to integrate and automate the entire process of a structural analysis. As a result of this, a significant amount of time can be saved by omitting the repetitive manual operations that a user should do. This saved time can be spent to improve the structural details and to analyse numerous alternatives before deciding the specifications of the definitive model. Another positive aspect of this work has been the experience that is gained during an optimization activity by using Isight. Even though this software facilitates so much the use of genetic algorithms, the quality of the results highly depends on the inserted parameters. The correct setting of these parameters is therefore very important to reach the real optimum with minimum effort. Consequently, the "decision maker" should also have a background of the optimization theory for a more efficient use.

8. Conclusions

Process integration and automation enable to significantly increase the efficiency of the entire process in terms of time and cost. Isight can be considered as a powerful but at the meanwhile a user-friendly tool which permits to facilitate this move. In addition to decreasing the cost and time which are essential for a company, an automated optimization sequence reduces also the effort due to repetitive operations. This fact lets the analyst to focus on his human role as a planner and decision maker.

This work can be considered as the core of a more complete structural design process. Further improvements can be made to the process by adding other two fundamental elements. The

² Recchia, V., "Development of structural optimization methodology of engine components by genetic algorithms", Ph.D. Thesis Politecnico di Torino, Dipartimento di Ingegneria Meccanica, 2010

first one regards the integration of a parametric CAD approach in the Work flow. This step would permit a wider range of application including the models that have even more complex geometries. The second process improvement that would permit to obtain a better design aims to increase the robustness of the entire system. The implementation of a stochastic analysis like Monte Carlo simulations can lead to a more robust design that assesses the impact of known uncertainties that may depend on manufacturing, design phase, approximations and so on. Once this kind of mentality is adopted for this specific field, more sophisticated multidisciplinary problems can be treated by combining the interaction between different fields.

[Visit the Resource Center for more SIMULIA customer papers](#)